

# Spectrophotometer *CM-36d* *CM-36dG*

## En **Instruction Manual**



Please read before using the instrument.



KONICA MINOLTA

## ■ Safety Symbols

The following symbols are used in this manual and on the product to prevent accidents that may occur because of incorrect use of the instrument.



**Denotes an instruction regarding a safety warning or note.**  
**Read the instruction carefully to ensure safe and correct use.**



**Denotes a prohibited operation.**  
**This operation must never be performed.**



**Denotes an instruction.**  
**This instruction must be strictly adhered to.**



**Denotes an instruction.**  
**Be sure to disconnect the plug from the outlet.**



**Denotes a prohibited operation.**  
**Never disassemble the instrument.**



**Be aware that there is the risk of electric shock.**



**This symbol indicates alternating current (AC).**



**This symbol indicates direct current (DC).**



**This symbol indicates class II protection against electric shock.**

## Trademarks













- Windows® is a registered trademark of Microsoft Corporation in the United States and other countries.
- The KONICA MINOLTA logo and symbol marks and SpectraMagic are registered trademarks of KONICA MINOLTA, Inc.

## Notes on this Manual

- Copying or reproduction of all or part of the contents of this manual without the permission of KONICA MINOLTA is strictly prohibited.
- The contents of this manual are subject to change without prior notice.
- Every effort has been made in the preparation of this manual to ensure the accuracy of its contents. However, should you have any questions or find any errors, please contact your retailer or a **KONICA MINOLTA-authorized service facility**.
- KONICA MINOLTA will not accept any responsibility for consequences arising from the use of the instrument.

# Safety Precautions

To ensure correct use of this instrument, read the following points carefully and adhere to them. After you have read this manual, keep it in a safe place where it can be referred to anytime a question arises.

	<b>WARNING</b> (Failure to adhere to the following points may result in death or serious injury.)
	Do not use the instrument in places where flammable or combustible gases (gasoline, etc.) are present. Doing so may cause a fire.
	Always use the AC adapter (AC-A312F) that was supplied as a standard accessory, and connect it to a 100 V ~ (50/60 Hz) AC outlet. If an AC adapter other than those specified by KONICA MINOLTA is used, or if the adapter is connected to an unsupported voltage, it may result in damage to the adapter, fire, or electric shock.
	If the instrument will not be used for a long time, disconnect the AC adapter power plug from the AC outlet. Accumulated dirt or water on the prongs of the AC adapter's plug may cause a fire. Clean off any dirt or water on the prongs of the AC adapter's plug before use.
	Do not insert or disconnect the AC adapter plug with wet hands. Doing so may cause electric shock.
	Do not disassemble or modify the instrument or the AC adapter. Doing so may cause a fire or electric shock.
	The instrument should not be operated if it or the AC adapter is damaged, or if smoke or abnormal odor occurs. Doing so may cause a fire. In such situations, turn the power OFF immediately, disconnect the AC adapter plug from the AC outlet, <b>and contact the nearest KONICA MINOLTA-authorized service facility.</b>
	Do not allow liquid or metal objects to enter the instrument and the AC adapter. Doing so may cause a fire or electric shock. Should liquid or metal objects enter the instrument, turn the power OFF immediately, disconnect the AC adapter power plug from the AC outlet, <b>and contact the nearest KONICA MINOLTA-authorized service facility.</b>
	Do not forcibly bend, twist, or pull the cords or cables. Also, do not scratch, modify, or place heavy objects on the cables. Doing so may damage the cable and cause a fire or electric shock.
	Always grasp the power plug itself when disconnecting the power cable from an outlet. Pulling on the power cable may damage it and cause a fire or electric shock.
	Firmly push the AC adapter power plug completely into the outlet. Incomplete insertion may cause a fire or electric shock.
	Do not look directly at the lamp. The lamp is extremely bright and emits ultraviolet rays. Looking directly at the light may injure the eyes.



## CAUTION

(Failure to adhere to the following points may result in injury or damage to the instrument or other property.)



Do not place the instrument on an unstable or sloping surface. Doing so may result in the instrument falling or overturning, causing injury. Be careful not to drop the instrument when carrying it as well.



Take care not to pinch yourself in the parts of the instrument that open and close. There is the risk of injury.



Do not use the instrument if the specimen measuring port (measurement area) is in the line of sight. Doing so may result in injury to the eye.



Take sufficient care when handling the glass cell.  
The glass of the glass cell may become cracked, resulting in injury.



When using the AC adapter, make sure that an AC outlet is located near the instrument, and that the AC adapter plug can be connected to and disconnected from the AC outlet easily.



When cleaning the instrument, unplug the AC adapter plug from the outlet. Failure to do so may result in electric shock.

# Introduction

The CM-36dG is a high-precision stationary spectrophotometer for use in a variety of industrial fields. It is capable of simultaneously measuring color (reflectance) and gloss of reflective and translucent objects in a single measurement. The CM-36d is also a high-precision, stationary spectrophotometer capable of measuring color (reflectance).

## Packing materials of the product

Be sure to keep all packing materials used for shipping the instrument (cardboard box, cushioning material, plastic bags, etc.). This instrument is a precision measuring instrument. When transporting the instrument to a service facility for maintenance or for other reasons, be sure to use the packing materials to minimize shock or vibration. If the packing materials are lost or damaged, contact a **KONICA MINOLTA-authorized service facility**.

## Sample Holder Protective Cap

The instrument is shipped without the target mask installed in the target mask mounting section. Therefore a protective cap is installed at the sample holder in order to protect the specimen measuring part (opening of the integrating sphere).

Remove the protective cap before using the instrument.

Also be sure to install the protective cap when the instrument is transported.

Store the protective cap carefully.

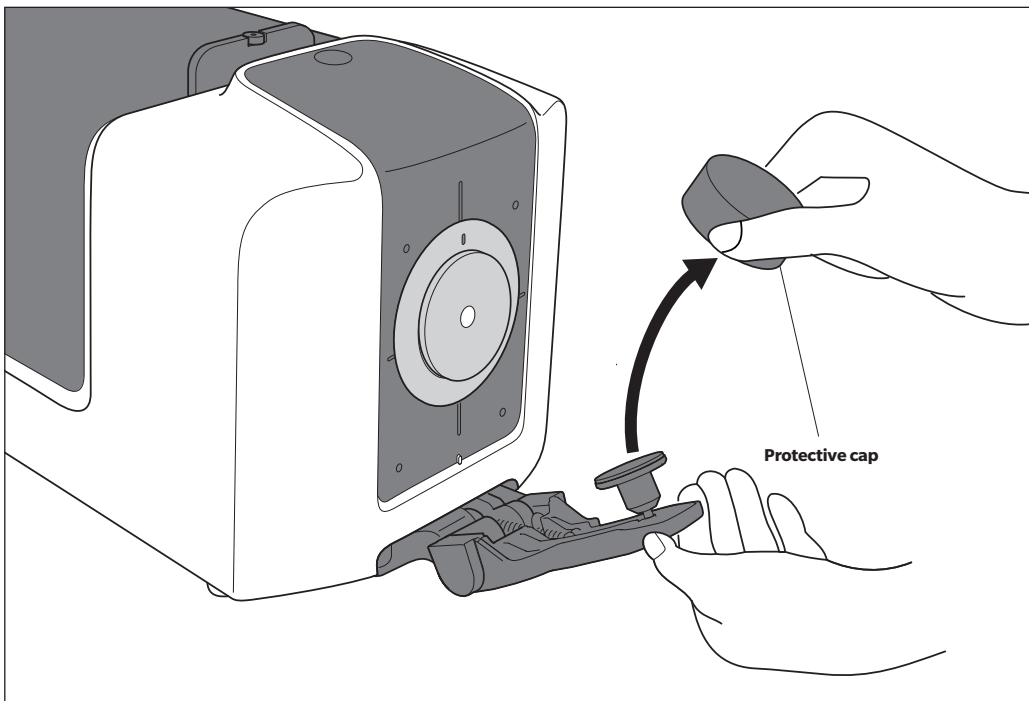

## Gloss Measurement and Transmittance Measurement

◆ in this manual indicates information related to gloss measurement or transmittance measurement. These are functions of the CM-36dG.

## ■ Notes on Use

### Operating Environment

- This instrument should be installed and used in an environment with an ambient temperature between 13°C and 33°C and a relative humidity of 80% or less (at 33°C) with no condensation. Use of the instrument outside this range will result in unsatisfactory performance.
- This instrument and the AC adapter supplied as a standard accessory (AC-A312F) have been designed exclusively for indoor use. Outdoor use is prohibited due to the risk of damage to the instrument caused by rain or other factors.
- This instrument is composed of precision electronic components. Never disassemble or modify the instrument as doing so may cause malfunction, electric shock, fire, or other accident.
- This instrument is a pollution level 2 product (equipment to be used primarily in manufacturing environments, laboratories, warehouses, and similar locations). This instrument should be used in environments where exposure to metallic dust or condensation is not a concern.
- This instrument is an overvoltage category I product (equipment for connection to circuits in which measures are taken to limit transient overvoltage to an appropriately low level).
- Take care to prevent foreign matter from entering the instrument. Using the instrument while subjected to intrusion of water or metals is extremely dangerous.
- Using the instrument in direct sunlight or near heating equipment can cause the internal temperature of the instrument to become much higher than the ambient temperature, resulting in malfunction. Do not use the instrument in such areas.
- Avoid subjecting the instrument to sudden temperature changes and condensation.
- Do not use the instrument in areas where dust, smoke, or chemical gases are present, or in extremely humid environments.
- Do not use the instrument at altitudes higher than 2,000 m.
- Do not use the instrument near equipment that produces a strong magnetic field (such as speakers).

### System

- Do not subject the instrument to strong vibrations or impacts.
- Do not pull, forcibly bend, or apply excessive force to the connected cables and cords. Doing so may cause the cable or cord to break.
- The instrument specimen measuring port and inside of the integrating sphere are particularly high-precision components of the optical system. Do not allow them to become dirty or subject them to impact. In addition, make sure to install the target mask and cover the specimen measuring port when the instrument is not in use.
- This instrument and the AC adapter are EMC Class B products. Use of the instrument and the AC adapter in home environments may cause radio interference. Users may be required to take appropriate measures in such cases.
- If the instrument is exposed to strong external static electricity, the display may go blank or fail to display information correctly. Communication with a connected external device may also be interrupted. In such cases, turn the power OFF and then ON again.
- When turning the power OFF and then ON again, wait several seconds after turning the power OFF before turning the power back ON.
- The instrument should be connected to a power source with as little noise as possible.
- When a malfunction or abnormal behavior occurs, turn the power OFF immediately, disconnect the AC adapter plug from the AC outlet, and refer to P.36 “Troubleshooting.”
- Should the instrument break down, do not try to disassemble and repair the instrument. Contact a **KONICA MINOLTA-authorized service facility**.

## Measurement

- Make sure no dust or dirt enters the openings of the instrument.
- When the instrument is used over a prolonged period, the measured values may deviate due to changes in the environment or other factors. In order to maintain good measurement accuracy, it is recommended that white calibration and gloss calibration be performed regularly.

## Calibration Plate (White Calibration and Gloss Calibration)

- The calibration data for the calibration plate was measured at 23°C. To achieve the highest accuracy when measuring absolute values, calibration and measurement should be performed at 23°C.
- Do not allow the calibration plate to become scratched or dirty.
- Do not move the calibration plate when it is installed in the sample holder. Doing so may scratch the calibration plate.
- When the calibration plate is not in use, be sure to close the cover so that the plate is not exposed to light.

## Target Mask

- Do not touch the target mask inner surface (black coated surface) with a hand, or allow it to become dirty or scratched.
- When the target mask is not in use, be sure to place it inside the accessory case (CM-A286) for storage so that it is not exposed to external light.

## Power Source

- Make sure that the power is turned OFF when the instrument is not in use.
- Always use the AC adapter supplied as a standard accessory (AC-A312F) and connect it to a 100 V (50/60 Hz) AC outlet.
- Use an AC power supply of the rated voltage (within  $\pm 10\%$ ).
- Make sure the AC adapter output plug is not short-circuited. Failure to do so may cause a fire or electric shock.
- Do not connect the AC adapter to an overloaded electrical circuit. In addition, do not wrap or cover the AC adapter with cloth or other material while in use. Doing so may cause an electric shock or fire.
- When removing the AC adapter from the instrument, first remove the power cord from the outlet, and then remove the output plug.

## Transmittance Specimen Chamber

- Do not spill specimens or other fluids onto the instrument. If a fluid contacts the instrument, immediately wipe the fluid off with a soft, dry cloth.

## ■ Notes on Storage

- This instrument should be stored at a temperature between 0°C and 40°C with relative humidity of 80% or less (at 35°C) and no condensation. Storing the instrument in an environment with high temperatures and high humidity will result in unsatisfactory performance. Storing the instrument together with the drying agent at or near room temperature is recommended.
- When transporting the instrument, use the packaging box that the instrument was shipped in. This box can protect the instrument from sudden temperature changes, vibration, and shock.
- Storing the instrument in direct sunlight or near heating equipment can cause the internal temperature of the instrument to become much higher than the ambient temperature, resulting in malfunction. Do not store the instrument in such areas.
- Make sure that the instrument is not subjected to condensation when stored. In addition, take care to prevent rapid temperature changes to prevent condensation from occurring when transporting the instrument to the storage location.
- Do not store the instrument in areas where dust, smoke, or chemical gases are present. Doing so may cause deterioration in performance or a malfunction.
- Dust inside the integrating sphere may prevent accurate measurement. When the instrument is not in use, be sure to attach the protective cap and install the sample holder onto the instrument.
- If dust enters the optical system from the transmittance specimen chamber, it may prevent accurate measurement. When the instrument is not in use, close the lid of the transmittance specimen chamber to prevent the intrusion of dust.
- Do not leave the instrument with the target mask installed for a prolonged period. The target mask may become stuck to the sample holder.
- If the instrument is left inside the cab or trunk of a vehicle, the temperature and/or humidity may exceed the allowable storage range, resulting in malfunction. Do not leave the instrument in such places.
- The calibration plate may become discolored if left in a place that is exposed to light. When the calibration plate is not in use, be sure to close the cover so that the plate is not exposed to light.
- When not in use, store the instrument in the packing used for shipment and keep it in a safe place.
- Take care not to pinch yourself in the parts of the accessory case that open and close. There is the risk of injury.

## ■ Notes on Cleaning

- If the instrument becomes dirty, wipe it with a soft, dry cloth. Never use organic solvents (such as naphtha or thinner) or other chemicals for cleaning.
- If there is dust or dirt on the lens or the receptor window, use a blower to blow it off. Never use organic solvents (such as naphtha or thinner) or other chemicals for cleaning.
- If the white calibration plate, inside of the zero calibration box, or target mask becomes dirty, wipe it with a soft, clean, and dry cloth. If the dirt does not come off easily, wipe with a cloth that was slightly moistened with ethanol. If the cloth becomes dirty, clean the cloth by washing it.
- If the gloss calibration plate becomes dirty, use a blower to blow off the dust, then wipe the dirt off using the standard accessory cleaning cloth. If the dirt on the calibration plate does not come off easily, wipe using a soft cloth dampened with ethanol.
- If the inside of the integrating sphere becomes dirty, contact a **KONICA MINOLTA-authorized service facility**.
- If you are unable to remove dirt from the instrument through the above procedure, or if the instrument becomes scratched, contact a **KONICA MINOLTA-authorized service facility**.
- If the light-receiving side optical system of the transmittance specimen chamber becomes dirty, contact a **KONICA MINOLTA-authorized service facility**.
- Should the instrument malfunction, do not try to disassemble and repair the instrument yourself. Contact a **KONICA MINOLTA-authorized service facility**.



## ■ Notes on Transporting

- In order to protect the specimen measuring part (opening of the integrating sphere) when transporting the instrument, remove the target mask and be sure to install the protective cap onto the sample holder before transporting it.
- When transporting the instrument, be sure to use the packing materials to minimize shock or vibration.
- When sending the instrument in for service, package and send the instrument and all accessories.

## ■ Maintenance and Inspection

- To maintain measurement accuracy, the instrument should be inspected once a year. For information on inspection, contact the nearest **KONICA MINOLTA-authorized service facility**.

## ■ Disposal Method

- Make sure that the instrument, all accessories, and the packing materials are either disposed of or recycled correctly in accordance with local laws and regulations.

# Table of Contents

■ Safety Symbols .....	i
Trademarks.....	i
Notes on this Manual .....	i
Introduction .....	3
■ Notes on Use .....	4
■ Notes on Storage .....	6
■ Notes on Cleaning .....	6
■ Notes on Transporting .....	7
■ Maintenance and Inspection .....	7
■ Disposal Method.....	7
Accessories.....	9
■ Standard Accessories.....	9
■ Optional Accessories .....	11
System Diagram .....	12
Names and Functions of Parts .....	14
Opening and Closing the Transmittance Specimen Chamber <sup>◇</sup> .....	15
Indicators .....	16
Cleaning Parts .....	17
Measurement Procedure .....	18
Preparation .....	19
<input type="checkbox"/> Connecting to a Computer .....	19
<input type="checkbox"/> Connecting the AC Adapter.....	20
<input type="checkbox"/> Turning the Power ON/OFF.....	20
Installing the Target Mask .....	21
<input type="checkbox"/> Mask Detection Function .....	22
Installing the Zero Calibration Box.....	23
Installing the White Calibration Plate .....	24
Installing the Gloss Calibration Plate <sup>◇</sup> .....	25
Installing the Transmittance Zero Calibration Plate <sup>◇</sup> (Option).....	26
Transmittance Measurement 100% Calibration <sup>◇</sup> Procedure .....	27
Setting a Specimen .....	28
■ Reflective Measurement/Gloss Measurement <sup>◇</sup> .....	29
■ Transmittance Measurement <sup>◇</sup> .....	30
Error Messages .....	32
Troubleshooting .....	36
Fluorescence Measurement <sup>◇</sup> .....	38
Specifications .....	39
Dimensions .....	41

# Accessories

Standard and optional accessories are available with the instrument.

**Memo** The shape of some products may be different from those shown.  
(◇) indicates an accessory only for the CM-36dG.

## Standard Accessories

### White Calibration Plate CM-A288

Used to perform white calibration.

**Memo** When the plate is not being used, close the cover to prevent the plate from becoming dusty or scratched and to protect it from external light.

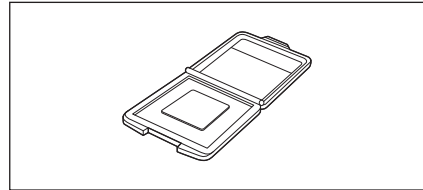

### Gloss Calibration Plate CM-A289 (◇)

Used to perform gloss calibration.

**Memo** When the plate is not being used, close the cover to prevent the plate from becoming dusty or scratched and to protect it from external light.

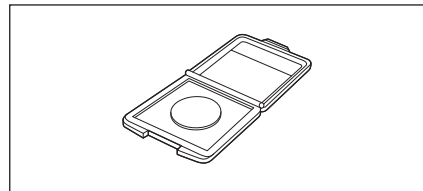

### Zero Calibration Box CM-A290

Used to perform zero calibration for reflectance measurement and gloss measurement, and to perform haze measurement for transmittance measurement.

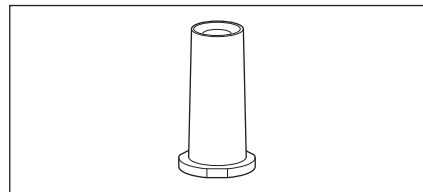

### Target Mask

#### CM-A291 / A292 / A293 / A294

This is used to change the illumination area (specimen measuring port size) according to the specimen. Each target mask measurement area/illumination area (specimen measuring port size) is as shown below.

CM-A291 (LAV)	: $\varnothing 25.4$ mm/ $\varnothing 30$ mm
CM-A292 (LMAV) (◇)	: $\varnothing 16$ mm/ $\varnothing 20$ mm
CM-A293 (MAV)	: $\varnothing 8$ mm/ $\varnothing 11$ mm
CM-A294 (SAV)	: $\varnothing 4$ mm/ $\varnothing 7$ mm

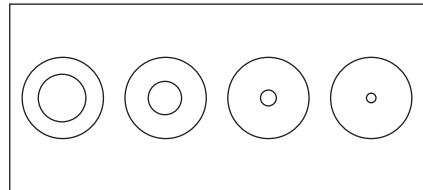

### AC Adapter AC-A312F

(ATS036T-A120)

This connects to an AC outlet using an AC cable and supplies power to the instrument.

Input: 100 to 240 V  $\sim$  50/60 Hz  
31 to 43 VA 0.31 to 0.18 A

Output: 12 V  $\text{---}$  3 A

Plug design:  Center-positive

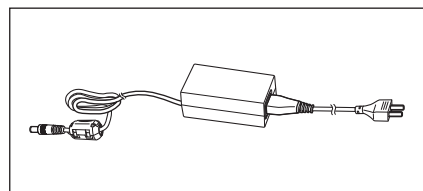

### USB Cable (2 m) IF-A17

Used to connect the instrument to a computer.

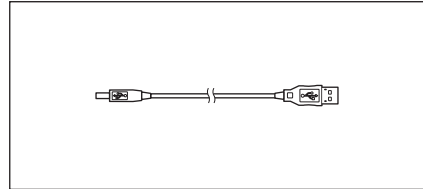

### Accessory Case CM-A286

This case is used to store all the accessories in one place.

**Notes** Use it for storage. Do not use it on its own for transport.

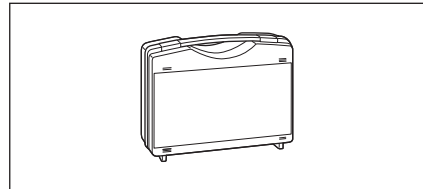

### Dust Cover CM-A295

This can prevent foreign substances from entering the instrument when it is stored in a location where there is much dust.

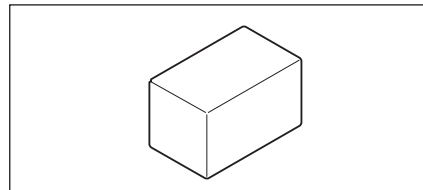

### Cleaning Cloth (◇)

Used to clean the gloss calibration plate.

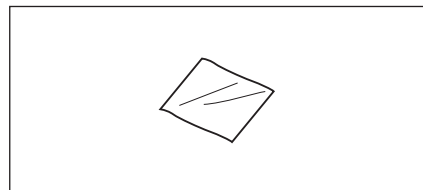

## ■ Optional Accessories

### DVD for Color Data Software SpectraMagic NX CM-S100w

(Ver. 3.2 or later)

This computer software is used to control the instrument and manage data from a computer.

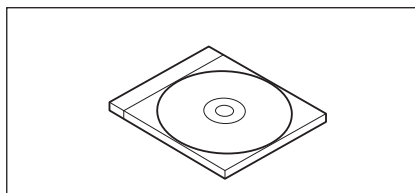

### UV Control Software for CM-36dG/V

This software is used to calculate the UV control coefficient and write it to the instrument when measuring a sample that includes fluorescence. It is provided on the same DVD as SpectraMagic NX (Ver. 3.2 or later).

**Notes** It can be used only when the Professional Version of SpectraMagic NX (Ver. 3.2 or later) is used.

### Color Plates (White, black, and 12 other colors)

Used for simple diagnosis of instrument measurement performance (instrument errors and repeatability).

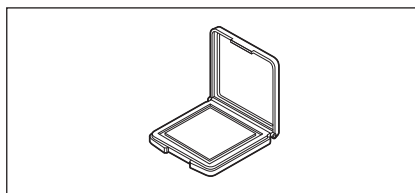

### Transmittance Specimen Holder (◇) CM-A96

Used to fasten the specimen during transmittance measurement.

The maximum thicknesses of the specimens that can be fastened is 22.5 mm.

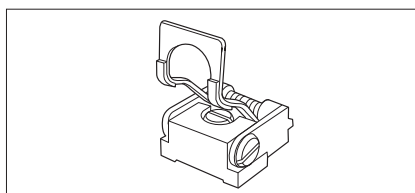

### Plastic Cell (◇)

**CM-A130 (optical path length 2 mm)**

**CM-A131 (optical path length 10 mm)**

**CM-A132 (optical path length 20 mm)**

This is a disposable plastic container which holds liquid samples.

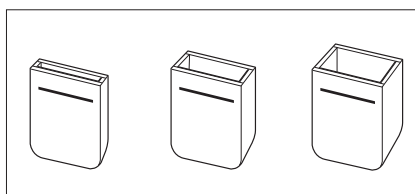

### Glass Cell (◇) **CM-A97 (optical path length 2 mm)**

**CM-A98 (optical path length 10 mm)**

**CM-A99 (optical path length 20 mm)**

This is a glass container which holds liquid samples.

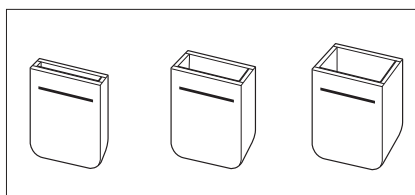

### Transmittance Zero Calibration Plate (◇) CM-A100

This is a light shield plate used when performing 0% calibration for transmittance measurement.

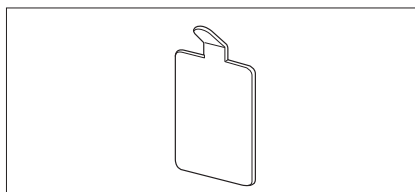

# System Diagram

## CM-36dG

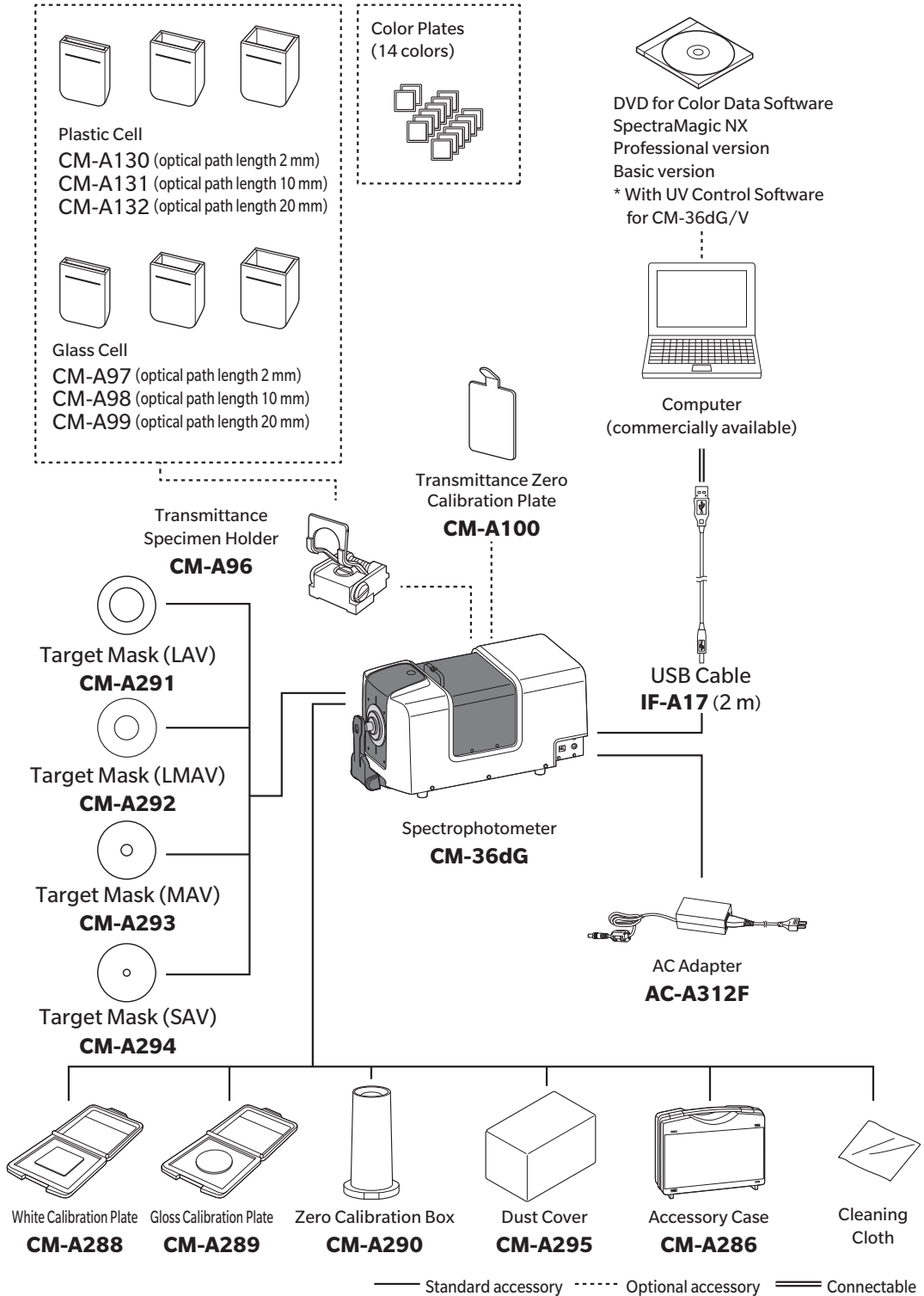

**CM-36d**

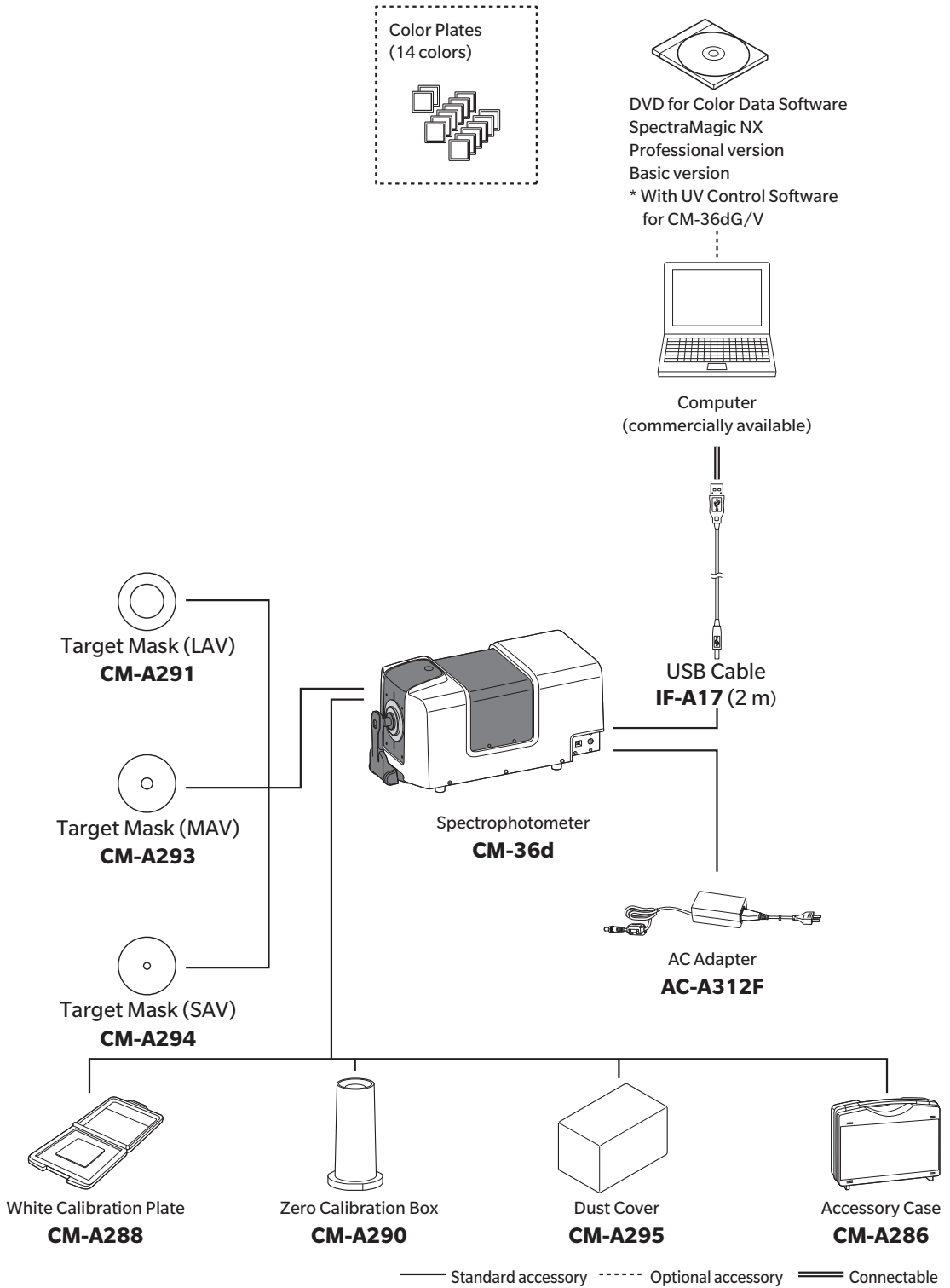

# Names and Functions of Parts

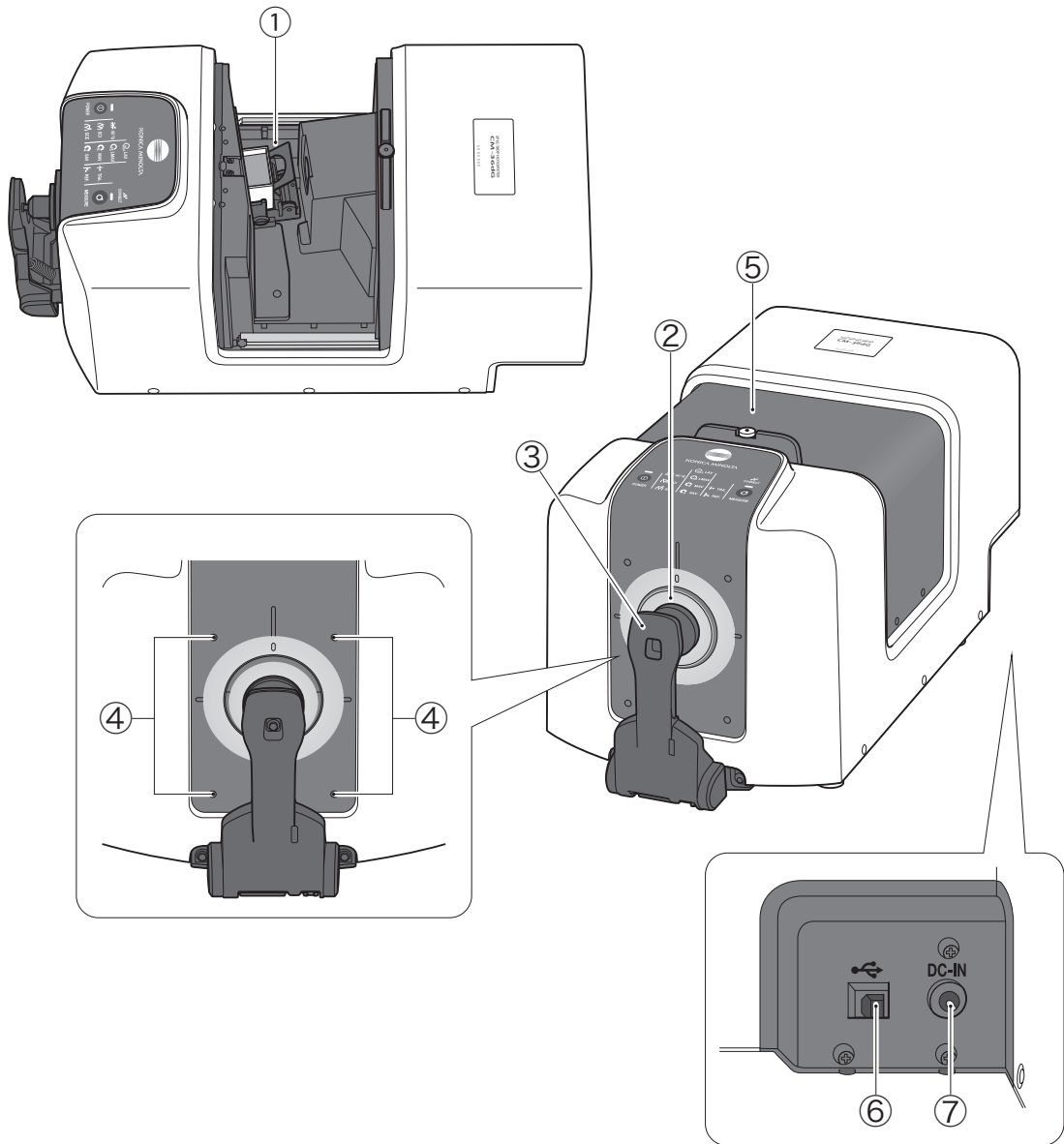

- ① **Transmittance specimen chamber** ♦ ... Used to install samples when performing transmittance measurement.
- ② **Target mask** ..... Select an illumination area of  $\varnothing 30$  mm (LAV),  $\varnothing 20$  mm (LMAV) ♦,  $\varnothing 11$  mm (MAV), or  $\varnothing 7$  mm (SAV) according to the specimen to be measured, and install into the instrument.
- ③ **Sample holder** ..... Installs the reflectance measurement specimen, white calibration plate, or gloss calibration plate.
- ④ **Jig mounting screw holes** ..... These screw holes are used to mount jigs or other components for fastening the specimen.
- ⑤ **Transmittance specimen chamber cover** ♦ ... Used to open and close the transmittance specimen chamber.
- ⑥ **USB connection terminal (B type)** ... Used to connect the instrument to a computer with the supplied USB cable (IF-A17).
- ⑦ **AC adapter input terminal** ..... Connects the provided AC adapter.



# Opening and Closing the Transmittance Specimen Chamber

## Opening the Transmittance Chamber

### Procedure

- 1 Pull the knob on the transmittance chamber cover up to unlock it.

Pulling it up frees the cover to open and close.

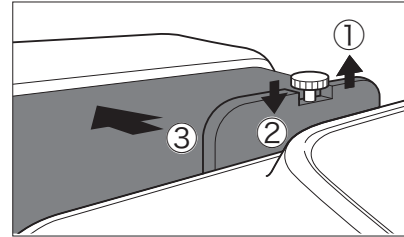

- 2 Under those conditions, slide open the cover.

**Notes** Take care not to pinch yourself in the parts that open and close.

The lock can be released when you want to slide the cover freely. Lift up the knob and rotate it 90 degrees to release the lock and free the cover to be opened and closed.

**Notes** Do not move the instrument while the cover is free to open and close. **Take care not to pinch yourself in the parts that open and close.**

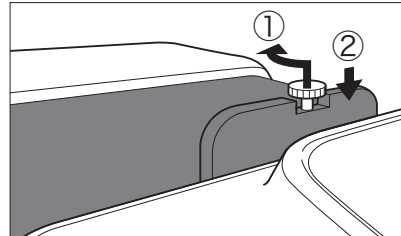

## Closing the Transmittance Chamber

### Procedure

- 1 Directly slide the cover closed so it closes securely. The cover is locked when it is closed to the point where it clicks.

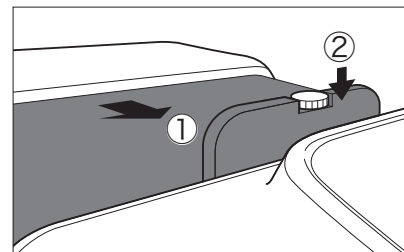
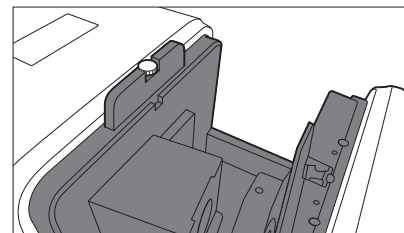

# Indicators



## Status panel and operation keys

### Operation keys

#### ① Power key

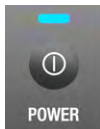

Used to turn the power ON/OFF. The instrument switches between ON/OFF every time the power key is pressed. The lamp illuminates blue when the power is ON.  
 ON: Press once.  
 OFF: Press and hold.

**Notes** • While the LED is flashing, the power ON/OFF process is in progress. Do not unplug the AC adapter.

#### ② Measurement key

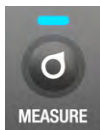

When the PC software was connected and a remote trigger was set, it becomes possible to perform measurement on the instrument side.

Illuminated (blue): Indicates that measurement is possible.  
 Illuminated (orange): Indicates that calibration has not been completed.  
 Not illuminated: Indicates measurement is in progress or the power is OFF

### Status panel

The LED illuminates to indicate the measurement mode that was set with the PC software.

#### ① Measurement mode



60° gloss<sup>◇</sup>  
 SCI  
 SCE

#### ② Measurement area



LAV  
 LMAV<sup>◇</sup>  
 MAV  
 SAV

#### ③ Reflectance/transmittance measurement mode

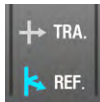

Reflectance measurement  
 Transmittance measurement<sup>◇</sup>

#### ④ Communication status



The LED illuminates when the product is connected to the computer (connected to the PC software).

# Cleaning Parts

## □ Zero Calibration Box

- Use a blower to blow off any dust inside the zero calibration box. If the dirt does not come off easily, wipe using a soft cloth dampened with ethanol. In such cases, be careful not to leave behind fingerprints or the like.

## □ White Calibration Plate/Gloss Calibration Plate <sup>◇</sup> (<sup>◇</sup> CM-36dG only)

- If the white calibration plate becomes dirty, use a blower to blow off the dust, then gently wipe the dirt off with a soft dry cloth.
- If the gloss calibration plate becomes dirty, use a blower to blow off the dust, then wipe the dirt off using the standard accessory cleaning cloth <sup>◇</sup>.
- If the dirt on the calibration plate does not come off easily, wipe using a soft cloth dampened with ethanol.
- If a part other than the calibration plate becomes dirty, gently wipe the dirt off with a soft cloth dampened with water or soapy water.

### Notes

- Be careful not to scratch the calibration plate.
- Never use solvents such as paint thinner or naphtha.
- Scratches or dirt on the white calibration plate or the gloss calibration plate may affect measurement values.

## □ Target Mask

- Use a blower to blow off dirt or dust on the target mask.
- If the dirt on the outside or inside surface of the target mask does not come off easily, remove the target mask from the instrument, and wipe the target mask using a soft cloth dampened with ethanol.

### Notes

- Do not touch the black painted surface of the target mask.

## □ Integrating Sphere

### 1 Remove the sample and all other objects from the illumination window of the transmittance specimen chamber.

### 2 Cover the receptor window of the transmittance specimen chamber so that no dust or dirt enters.

### 3 Open the sample holder and use a blower to blow off any dirt or dust.

- Do not touch the white-coated inner surface of the integrating sphere, wipe it with a cloth, or put an object inside it. If it becomes dirty and the dirt cannot be removed by a blower, contact a KONICA MINOLTA-authorized service facility.

## □ Receptor Window of the Transmittance Specimen Chamber <sup>◇</sup>

### 1 Set the measurement area to SAV from the software.

**Memo** • The lens is moved forward, making it easier to clean.

### 2 Use a blower to blow off dirt or dust from the receptor window.

Do not insert a finger into the receptor window or touch the viewing system lens.

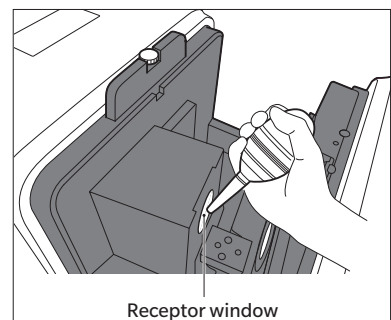
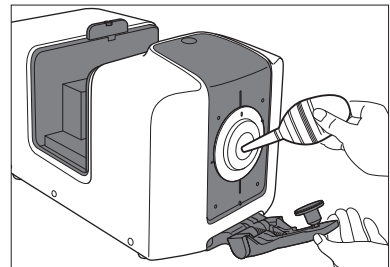
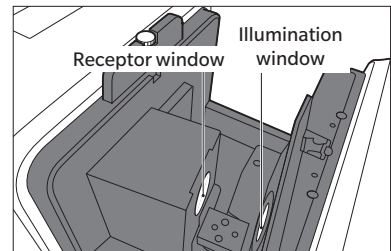

# Measurement Procedure

- This manual explains the measurement preparation procedure, specimen setting procedure, and other procedures for measurement with the CM-36dG/36d.
- Control is performed and measurement is executed from the computer connected to the instrument by using the optional SpectraMagic NX (CM-S100w) color data software.
- For the measurement procedure using SpectraMagic NX (CM-S100w), refer to the CM-S100w instruction manual.

## Flow of Measurement

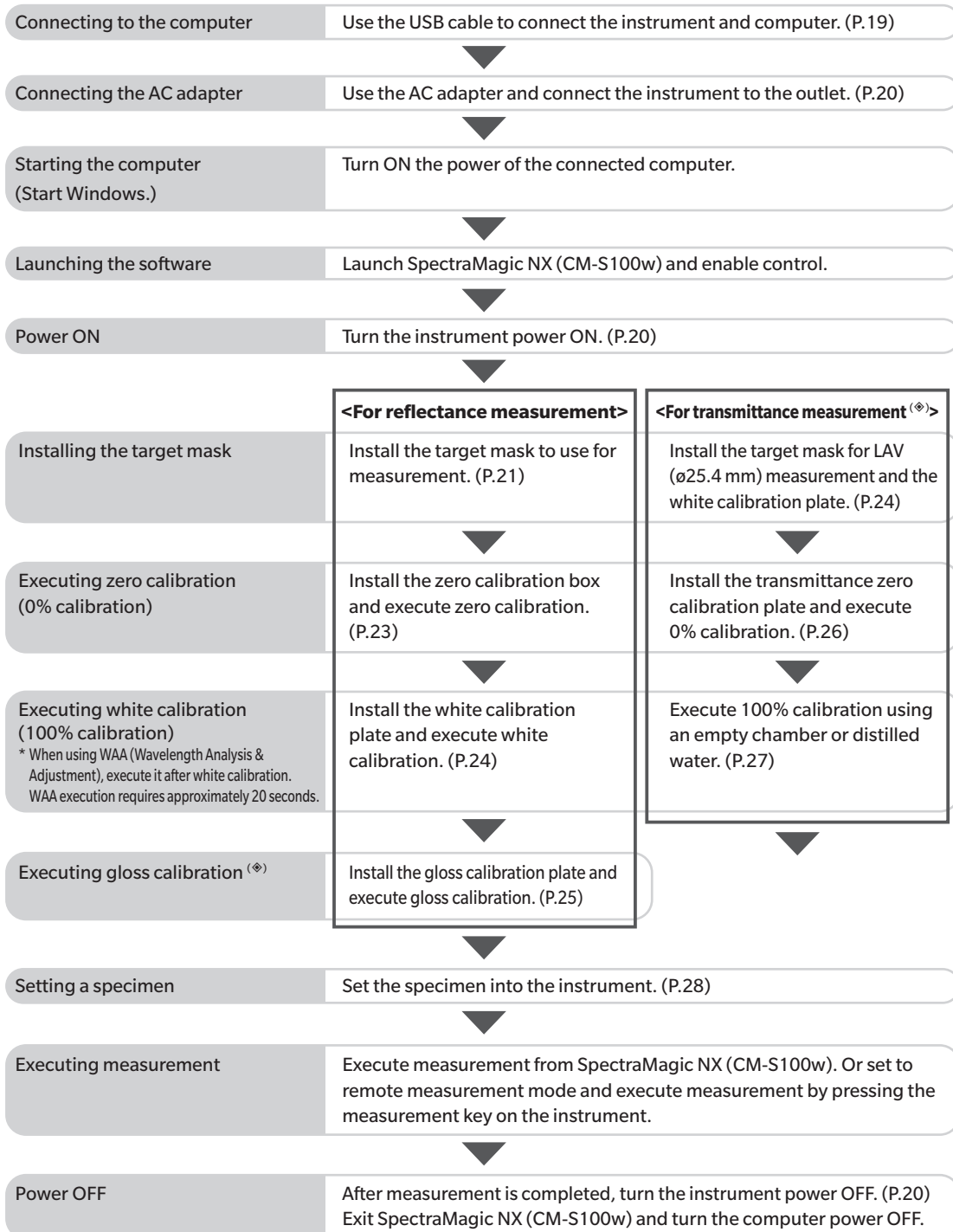

# Preparation

## □ Connecting to a Computer

Connect the instrument to the computer with the supplied USB cable IF-A17 (2 m).

**Notes** Be sure to connect the USB cable to the designated USB terminal on the instrument when it is used.

**Memo** • Instrument USB communications conform to USB 2.0.

- When connecting the instrument to the computer, the dedicated USB driver must be installed. Install the USB driver supplied with the software that enables connection and operation of the instrument.
- The instrument cannot be powered through the USB cable. Connect the AC adapter before use.
- Make sure that the USB connector plug is oriented correctly and connected securely.
- When connecting/disconnecting the USB cable, be sure to hold the connector plug. Do not pull on or forcibly bend the cable. Otherwise, wire breakage may result.
- Make sure that the cable has sufficient length. Putting tension on the cable may cause connection failure or wire breakage.
- Firmly push in the USB cable connector that matches the shape of the port (connection terminal) until it can go in no further.

### Setting Procedure

In general, a USB cable can be connected/disconnected while the instrument is turned ON. However, in the following procedure, the instrument is turned OFF before connecting. For information about connecting the AC adapter and power ON/OFF, refer to P.20.

#### 1 Turn the instrument power OFF.

#### 2 Connect the USB cable Type-B connector to the USB terminal on the instrument.

- Fully insert the connector and ensure the connection is secure.

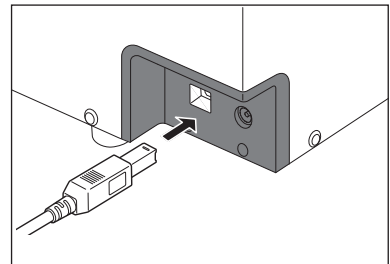

#### 3 Connect the USB cable Type-A connector to the USB port on the computer.

#### 4 Connect the AC adapter and turn the instrument power ON.

- When installation of the USB driver is prompted, specify the USB driver included with the software to complete the installation.
- After installation of the USB driver is completed, turn the power OFF and then back ON again.

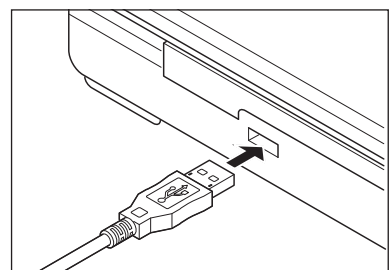

## □ Connecting the AC Adapter

- Notes**
- To supply AC power to the instrument, always use the AC adapter (AC-A312F) that was supplied with the instrument.
  - Insert the AC adapter plug all the way.

### Operating Procedure

- 1 Check that the power of both the instrument and computer is OFF (LED lamp is not illuminated).
- 2 Connect the DC output plug of the AC adapter to the DC input terminal on the side of the instrument.
- 3 Connect the AC adapter power plug to a 100 V (50/60 Hz) AC outlet.

- Notes** Be sure that the power switch is OFF before inserting or removing the DC output plug of the AC adapter.

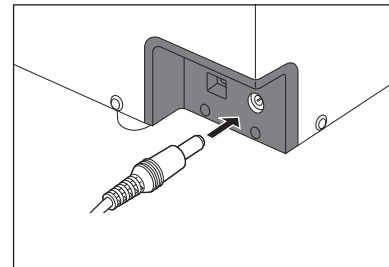

## □ Turning the Power ON/OFF

### Operating Procedure

#### Turning the Power ON

- 1 With the power OFF, press and hold the power key for around 1 second.

The power turns ON and the LED lamp above the power key illuminates blue.

- Notes**
- After pressing the power key, the LED lamp flashes until power ON is completed. While the LED is flashing, the start process is in progress. Do not unplug the AC adapter.



#### Turning the Power OFF

- 1 Press and hold the power switch for around 3 seconds.

The power will turn OFF. The LED lamp flashes and then turns off.

- Notes**
- After pressing the power key, the LED lamp flashes until power OFF is completed. While the LED is flashing, the shutdown process is in progress. Do not unplug the AC adapter.



# Installing the Target Mask

With this instrument, the target mask can be selected according to the specimen being measured and application.

Target masks	LAV	CM-A291	(measurement area $\varnothing 25.4$ mm / illumination area $\varnothing 30$ mm)
	LMAV	CM-A292	(measurement area $\varnothing 16$ mm / illumination area $\varnothing 20$ mm) <sup>(◆)</sup>
	MAV	CM-A293	(measurement area $\varnothing 8$ mm / illumination area $\varnothing 11$ mm)
	SAV	CM-A294	(measurement area $\varnothing 4$ mm / illumination area $\varnothing 7$ mm)

**Memo** • (◆) Not included with CM-36d.

## Procedure

- 1 Pull the sample holder toward you and hold it so it is opened.**
- 2 Pull the currently installed target mask toward you to remove it.**

**Memo**

- The target mask is fastened by a magnet.
- There are notches on the left and right of the instrument contact surface. Placing your hand so that your thumb and index finger are positioned on the notches will make it easier to remove.

- 3 Orient so that the instrument target mask mark (●) is facing up, and install the target mask so that the outer periphery fits onto the indentation of the integrating sphere.**

**Memo**

- Install the target mask with the black painted surface on the inside (CM-36d/36dG side).

**Notes**

- If the installation direction of the target mask is not correct, it will not fit properly in place. Check the direction and fit the target mask in place, then check that there is no looseness or lifting.

- 4 Return the sample holder to its original position.**

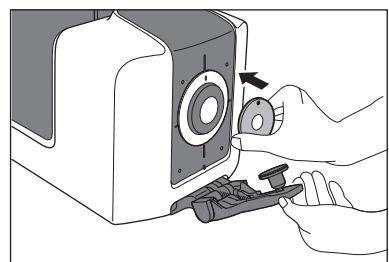
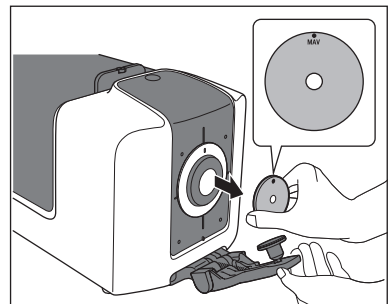
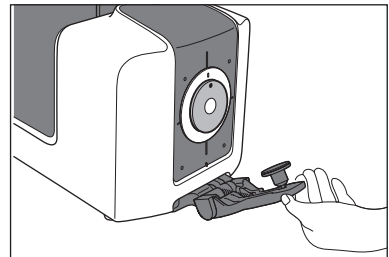

## Precautions for Use of the Target Mask

- Do not scratch the target mask inner surface (black coated surface), or allow it to be dirtied by fingerprints or other dirt.
- The target mask may become discolored if left in a place that is exposed to light. Therefore store the target mask in the accessory case (CM-A286) when it is not in use.
- Do not leave the instrument with the target mask installed for a prolonged period. The target mask may become stuck to the sample holder.

## □ Mask Detection Function

This product detects the size of the target mask that is installed, and automatically changes the instrument light-receiving lens to the correct position.

### Operating Procedure

#### 1 Use the optional software (SpectraMagic NX) and turn ON the mask detection function.

#### 2 Install the target mask.

The light-receiving lens moves to the correct position for the size of the detected target mask.

**Memo** • For the installation procedure, refer to “Installing the Target Mask” on P.21 of the instruction manual.

**Notes** • **Incorrect detection may occur if the target mask is not installed correctly, or if it is dirty or scratched.**

#### 3 Check that the indicator display matches the size of the installed mask.

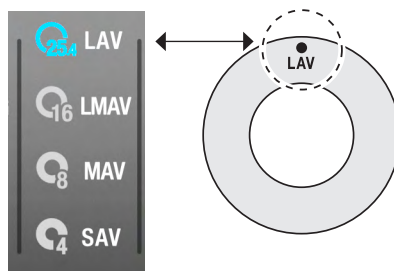

If the sizes do not match, check the following two points and perform the operation again.

- Check that the target mask is installed correctly.
- Check that there is no dirt or scratching on the mounting surface of the target mask. If there is dirt, use a blower to remove any dust, dirt, and other substances. If the dirt does not come off easily, wipe using a soft cloth dampened with ethanol.

If the above does not resolve the problem, contact a KONICA MINOLTA-authorized service facility.



# Installing the Zero Calibration Box

The zero calibration box is used to perform zero calibration for reflectance measurement, and to perform haze measurement for transmittance measurement.

- Perform this calibration when there is no specimen in the transmittance specimen chamber.
- Install the target mask to use for measurement in advance.
- From the software in advance, set the same measurement area, specular component (SCI/SCE), and UV output that will be used for measurement.

For fluorescence measurement that does not require strict accuracy (fluorescence calibration is not performed), perform measurement under UV full light source.

## Procedure

- 1 Pull the sample holder toward you and hold it so it is opened.**

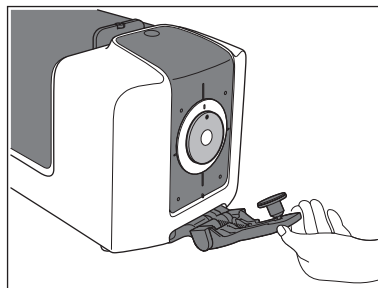

- 2 Fit the zero calibration box into the indentation on the instrument.**

### Memo

- The zero calibration box is fastened by a magnet.
- After fitting the zero calibration box in place, check that there is no looseness.

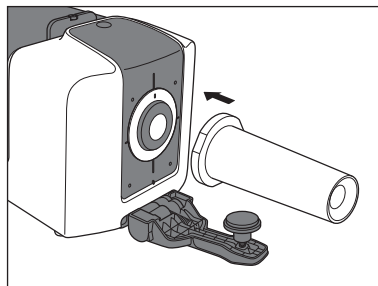

## Precautions for Use of the Zero Calibration Box

- Do not apply any force to the zero calibration box after it is installed. Doing so may cause the zero calibration box to fall off.
- Be careful not to scratch or allow fingerprints or other dirt to contact the inside of the zero calibration box.
- If the inside of the zero calibration box becomes dirty, wipe it gently with a soft, clean, and dry cloth.
- If the dirt on the zero calibration box does not come off easily, wipe using a cloth dampened with ethanol.
- If the inside is scratched or the dirt cannot be removed, replace the zero calibration box.

# Installing the White Calibration Plate

The white calibration plate is used to perform white calibration for reflectance measurement, and to perform transmittance measurement<sup>(\*)</sup> (0% calibration, 100% calibration, measurement).

- Perform this calibration when there is no specimen in the transmittance specimen chamber.
- Install the target mask to use for measurement in advance.
- From the software in advance, set the same measurement area and specular component (SCI/SCE) that will be used for measurement.

For fluorescence measurement that does not require strict accuracy (fluorescence calibration is not performed), perform measurement under UV full light source.

- Notes**
- When using WAA (Wavelength Analysis & Adjustment), execute it after white calibration. WAA execution requires approximately 20 seconds.

## Procedure

- 1 Pull the sample holder toward you and hold it so it is opened.

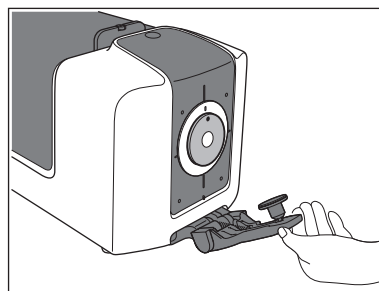

- 2 As shown in the figure, press on the sample holder so that the sample holder fits into the indentation on the reverse side of the white calibration plate.

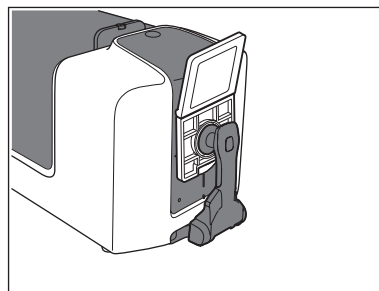

## Precautions for Use of the White Calibration Plate

- Memo**
- White calibration data is used when performing white calibration using the white calibration plate. White calibration data is set in the instrument at the time when it is purchased.
  - The white calibration plate may become discolored if left exposed to light. Therefore, make sure to close the cap when the plate is not in use in order to prevent the plate from being exposed to external light.
  - Be careful that the white calibration plate does not become scratched and does not contact fingerprints or other dirt.
  - If the white calibration plate becomes dirty, wipe it gently with a soft, clean, and dry cloth.
  - If the dirt does not come off easily, wipe it off with a cloth dampened with ethanol, then wipe off the ethanol with a cloth dampened with water, and allow the white calibration plate to dry before using.
  - If the white calibration plate is scratched or the dirt cannot be removed, replace it. After the white calibration plate was replaced, set the white calibration data to the data for the new white calibration plate.

# Installing the Gloss Calibration Plate

The gloss calibration plate is used when performing gloss calibration.

Install the target mask to use for measurement in advance.

From the software in advance, set the same measurement area, specular component (SCI/SCE), and UV output that will be used for measurement.

## Procedure

- 1 Pull the sample holder toward you and hold it so it is opened.**

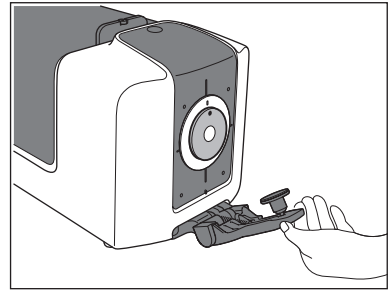

- 2 As shown in the figure, press on the sample holder so that the sample holder fits into the indentation on the reverse side of the gloss calibration plate.**

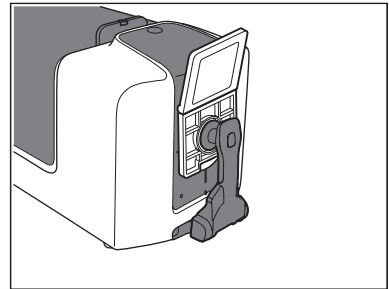

## ■ Precautions for Use of the Gloss Calibration Plate

### Memo

- Gloss calibration data is used when performing gloss calibration using the gloss calibration plate. Gloss calibration data is set in the instrument at the time when it is purchased.
- The gloss calibration plate may become discolored if left exposed to light. Therefore, make sure to close the cap when the plate is not in use in order to prevent the plate from being exposed to external light.
- Be careful that the gloss calibration plate does not become scratched and does not contact fingerprints or other dirt.
- If the gloss calibration plate becomes dirty, use a blower to blow off the dust, then wipe the dirt off using the standard accessory cleaning cloth.
- If the dirt on the calibration plate does not come off easily, wipe using a soft cloth dampened with ethanol.
- If a part other than the calibration plate becomes dirty, gently wipe the dirt off with a soft cloth dampened with water or soapy water.
- If the gloss calibration plate is scratched or the dirt cannot be removed, replace it. After the gloss calibration plate was replaced, set the gloss calibration data to the data for the new gloss calibration plate.

# Installing the Transmittance Zero Calibration Plate <sup>◇</sup> (Option)

The transmittance zero calibration plate is used when performing 0% calibration for transmittance measurement.

- When using the optional SpectraMagic NX, set the measurement method to transmittance in advance.
- Install the target mask for LAV measurement and the white calibration plate onto the instrument.

## Procedure

### 1 Open the transmittance specimen chamber cover.

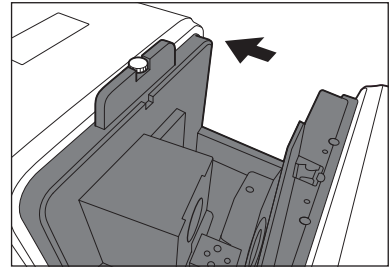

### 2 Install the transmittance zero calibration plate in a position so that it completely covers the illumination window.

- Memo**
- When using the optional transmittance specimen holder, install the transmittance zero calibration plate into the transmittance sample holder. For information about installing the transmittance specimen holder, refer to the instruction manual that was provided with the transmittance specimen holder.

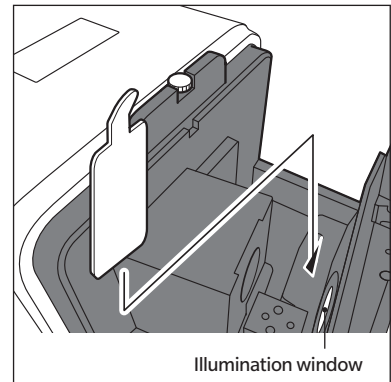

### 3 Close the transmittance specimen chamber cover.

## ■ Precautions for Use of the Transmittance Zero Calibration Plate

- Be careful that the transmittance zero calibration plate does not become scratched and does not contact fingerprints or other dirt.
- If the transmittance zero calibration plate becomes dirty, wipe it gently with a soft, clean, and dry cloth.
- If the dirt does not come off easily, wipe using a soft cloth dampened with ethanol.
- If the transmittance zero calibration plate is scratched or the dirt cannot be removed, replace it.

# Transmittance Measurement 100% Calibration Procedure

Transmittance measurement 100% calibration can be performed with nothing set in the transmittance specimen chamber or using the cell (option) and distilled water (or pure water).

- Memo**
- When measuring a liquid sample using the cell (option), perform 100% calibration using the cell and distilled water (or pure water).
  - When using the optional SpectraMagic NX, set the measurement method to transmittance in advance.
  - Install the target mask for LAV measurement and the white calibration plate onto the instrument.

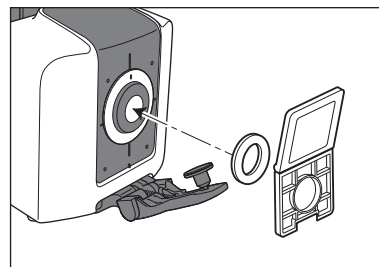

For fluorescence measurement that does not require strict accuracy (fluorescence calibration is not performed), perform measurement under UV full light source.

When the below setup is completed, execute 100% calibration from the software.

## Measuring a Specimen Without Using a Plastic Cell or Glass Cell

### Procedure

**1 Open the transmittance specimen chamber cover.**

**2 Empty the space between the illumination window and receptor window. (Perform without a sample, cell, transmittance zero calibration plate, or other item installed.)**

- Memo**
- There will be no effect on the measurement results if the optional transmittance specimen holder CM-A96 is installed. However in this case, it is necessary to perform measurement with the zero calibration transmittance sample holder installed.

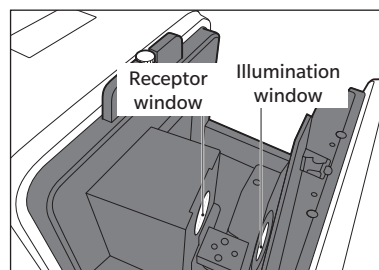

**3 Close the transmittance specimen chamber cover.**

## Measuring a Specimen Using a Plastic Cell or Glass Cell and Distilled Water (or Pure Water)

### Procedure

**1 Open the transmittance specimen chamber cover.**

**2 Set a cell that is around 2/3 full of distilled water (or pure water) onto the transmittance specimen holder on the illumination window side.**

- Although the transmittance specimen holder can be installed on either the illumination window side or receptor window side, it should be installed on the illumination/windowing system uses diffuse illumination and 0° viewing.
- The cell used for calibration must have the same optical path length as the cell that will be used for measurement.
- Set the cell in place with the transparent surfaces facing toward the receptor window and illumination window.

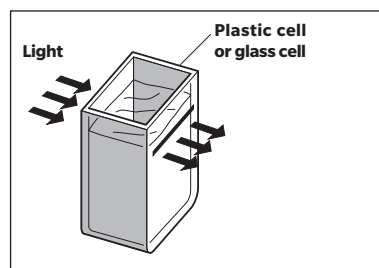

**3 Close the transmittance specimen chamber cover.**

# Setting a Specimen

## Reflectance Measurement P.29

When measuring the reflectance of a film or plate specimen, install the specimen into the sample holder before setting it onto the instrument. When measuring a specimen that is not fit into the sample holder, remove the sample holder and measure with the specimen measuring port in close contact with the specimen.

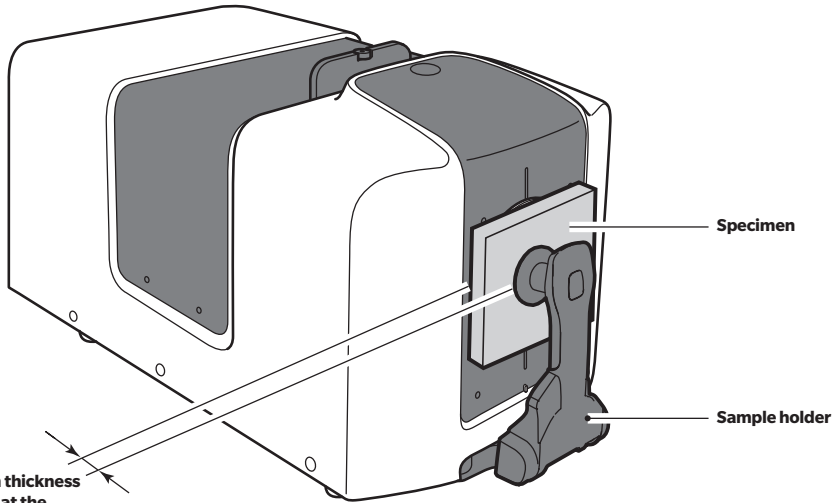

### Notes

The maximum thickness of a specimen at the part which is fit into the sample holder is 30 mm.

## Transmittance Measurement (◇) P.30

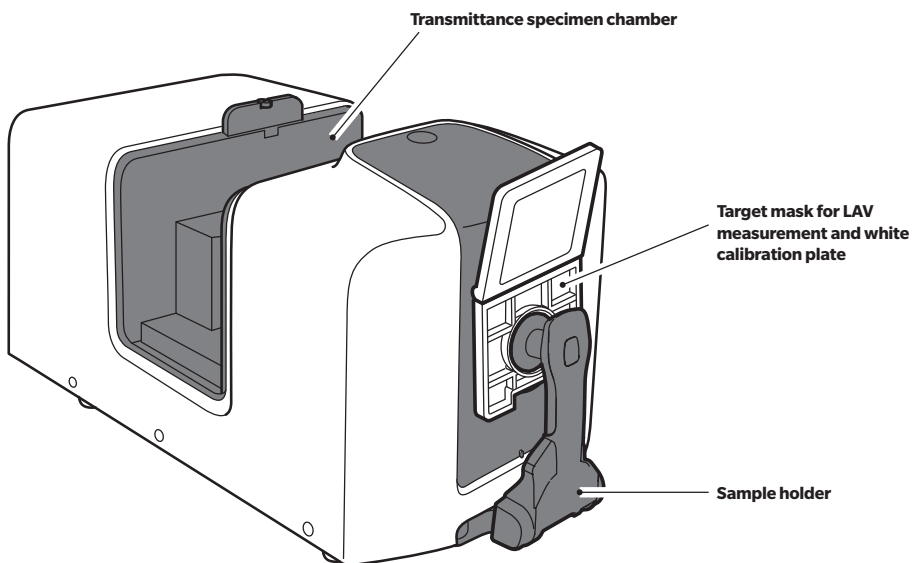

## ■ Reflective Measurement/Gloss Measurement<sup>◇</sup>

- Perform this calibration when there is no specimen in the transmittance specimen chamber.
- Install the target mask to use for measurement in advance.
- From the software in advance, set the measurement area, the specular component, and UV output.

### Procedure

- 1 Pull the sample holder toward you and hold it so it is opened.**

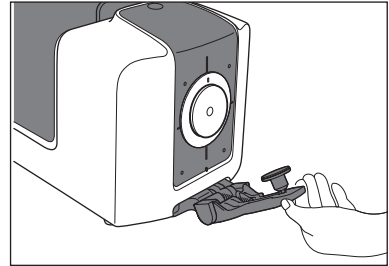

- 2 Insert the sample into the sample holder.**

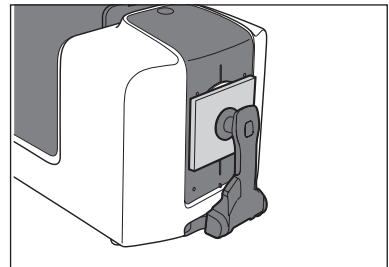

- 3 Position the specimen so that the part you want to measure is within the measurement points.**
  - When moving the specimen position, pull the sample holder toward you and hold it so it is opened in order to protect the sample surface.
  - Do not open the transmittance specimen chamber cover during measurement. Doing so may prevent accurate measurement.

**Memo** If you want to check the measurement location, connect the instrument to the computer and use the viewfinder function of the SpectraMagic NX software.

- 4 Use the optional SpectraMagic NX (CM-S100w) color data software and perform measurement. When remote measurement mode is selected, measurement can also be performed using the measurement key on the instrument status panel.**

## ■ Opacity Measurement

When the optional SpectraMagic NX (CM-S100w) color data software is used, opacity is calculated based on two types of measurements: white background and black background.

## ■ Transmittance Measurement

- When using the optional SpectraMagic NX, set the measurement method to transmittance in advance.
- Install the target mask for LAV measurement and the white calibration plate onto the instrument.

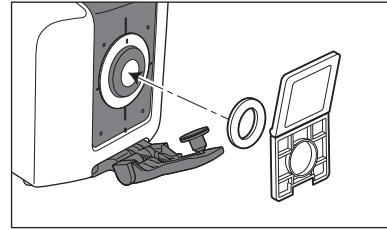

### Procedure

#### 1 Open the transmittance specimen chamber cover.

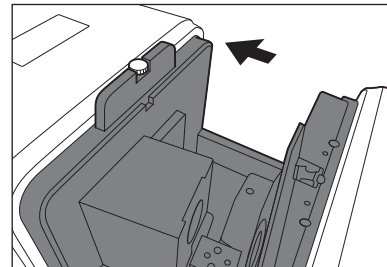

#### 2. Place the specimen (or the container containing the specimen when measuring a liquid specimen) in close contact with the illumination window side.

- Set the specimen so that the part that will be measured completely covers the illumination window.

#### Memo

- Although the specimen can be set on either the illumination window side or receptor window side, it should be set on the illumination window side for ordinary use. In this case, the illumination/viewing system uses diffuse illumination and 0° viewing (di: 0°, de: 0°).  
When the specimen is set on the receptor window side, the measurement type is approximately 0°:0°. Although this does not completely match the definition in JIS Z 8722 or other standards, it can be used as a relative value for management.
- For setting specimens that are difficult to hold or specimens with the designated thickness, use of the optional transmittance specimen holder CM-A96 is recommended. For information about installing the transmittance specimen holder, refer to the instruction manual that was provided with the transmittance specimen holder.
- When measuring a liquid specimen, use of an optional glass cell (CM-A97 to 99) or plastic cell (CM-A130 to 132) is recommended.
- When using a container other than CM-A97 to 99 or CM-A130 to 132, use a container which is colorless and transparent, and which has a shape that is parallel to the illumination window and receptor window.
- Do not spill specimens or other fluids onto the instrument. If a fluid contacts the instrument, immediately wipe the fluid off with a soft, dry cloth.
- Do not measure flammable fluids.

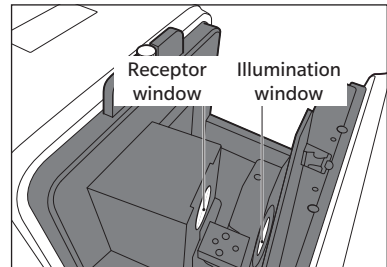



- Perform measurement when the specimen or the inside and outside of the container containing the specimen are free of scratches, fingerprints, and other dirt. If the measurement surface is grasped with a hand, fingerprints will be left on it. Hold the specimen at a part which is not the measurement surface.
- If there are bubbles on the inside of the container containing the specimen, accurate measurement will not be possible. Remove the bubbles before performing measurement. (Bubbles may form spontaneously when a specimen is left in the container.)
- If there is condensation or other water droplets on the specimen or the container containing the specimen, accurate measurement will not be possible.
- When measuring a liquid which contains minute particles, accuracy will be unstable due to precipitation of the particles.

**3 Close the transmittance specimen chamber cover.**

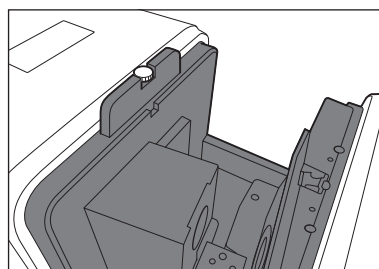

**4 Use the optional SpectraMagic NX (CM-S100w) color data software and perform measurement. When remote measurement mode is selected, measurement can also be performed using the measurement key on the instrument status panel.**

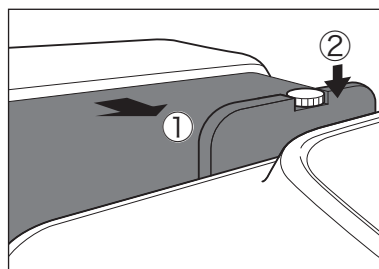

**■ Haze Measurement**

When the white calibration plate is installed at the specimen measuring port for reflectance measurement, the measurement type is di: 0°. When the zero calibration box is installed instead of the white calibration plate, the measurement type is de: 0°.

Although the illumination/viewing system does not completely match the definition of haze (ASTM D 1003), it can be used as a relative value for management.

When using the optional SpectraMagic NX (CM-S100w) color data software for haze measurement, haze is calculated from these 2 measurements.

# Error Messages

During control from the computer connected to the instrument using the optional SpectraMagic NX (CM-S100w) color data software, error messages such as the following may be displayed on the SpectraMagic NX (CM-S100w) operating screens.

When a message is displayed, perform the correction shown below. If the conditions do not return to normal after performing the correction, contact a KONICA MINOLTA-authorized service facility.

Symptom	Displayed message	Possible cause	Correction	CM-36dG	CM-36d
Warning	Because much time has passed since calibration, it is recommended that calibration be performed again.	A certain amount of time passed after white calibration.	Perform white calibration again.	●	●
	Regularly scheduled device calibration is approaching.	The time when regularly scheduled device calibration is required has arrived.	For regularly scheduled device calibration, contact a KONICA MINOLTA-authorized service facility.	●	●
	Regularly scheduled device calibration is required. Have regularly scheduled device calibration performed.	A certain amount of time passed after regularly scheduled device calibration.	For regularly scheduled device calibration, contact a KONICA MINOLTA-authorized service facility.	●	●
	The reflectance is outside the range of guaranteed performance.	The reflectance of the measured specimen was more than 200%.	-	●	●
	The gloss value is outside the range of guaranteed performance.	The gloss value of the measured specimen was 200 to 400.	-	●	
	The reflectance and gloss value are outside the range of guaranteed performance.	The reflectance of the measured specimen was more than 200%, and the gloss value was 200 to 400.	-	●	
	The gloss value exceeded the upper limit.	Gloss measurement with that specimen is not possible.	To perform gloss measurement, measure using a different specimen.	●	
	The light intensity of the light source used for color measurement has dropped.	The light intensity of the light source used for color measurement has dropped.	To replace the color measurement light source, contact a KONICA MINOLTA-authorized service facility.	●	●

Symptom	Displayed message	Possible cause	Correction	CM-36dG	CM-36d
	The light intensity of the light source used for gloss measurement has dropped.	The light intensity of the light source used for gloss measurement has dropped.	To replace the gloss measurement light source, contact a KONICA MINOLTA-authorized service facility.	●	
	The light intensity of the light source used for color measurement and the light source used for gloss measurement have dropped.	The light intensity of the light source used for color measurement and the light source used for gloss measurement have dropped.	To replace the color measurement light source and gloss measurement light source, contact a KONICA MINOLTA-authorized service facility.	●	
	Expiration of the wavelength correction (WAA) license is approaching.	The time when wavelength correction license renewal is required has arrived.	To renew the wavelength correction license, contact a KONICA MINOLTA-authorized service facility.	●	●
	The wavelength correction (WAA) license has expired.	The wavelength correction license has expired.	To renew the wavelength correction license, contact a KONICA MINOLTA-authorized service facility.	●	●
	The light intensity of the light source used for wavelength correction (WAA) has dropped.	The light intensity of the light source used for wavelength correction has dropped.	To replace the wavelength correction light source, contact a KONICA MINOLTA-authorized service facility.	●	●
Error	No response from the instrument.	Communication with the instrument failed. <ul style="list-style-type: none"> <li>• The instrument power is OFF.</li> <li>• The COM port setting is incorrect.</li> <li>• The communication condition settings are incorrect.</li> </ul>	Turn ON the instrument power. Check the COM port and communication conditions, and set the correct conditions.	●	●
	The required advance calibration has not been performed.	Zero calibration or white calibration has not been performed.	Perform zero calibration and white calibration.	●	●
	Install the zero calibration box and appropriate target mask, and perform calibration.	Zero calibration was not performed using the correct procedure.	Perform zero calibration using the provided zero calibration box and appropriate target mask.	●	●

Symptom	Displayed message	Possible cause	Correction	CM-36dG	CM-36d
	Install the white calibration plate and appropriate target mask, and then perform calibration.	White calibration was not performed using the correct procedure.	Perform white calibration using the provided white calibration plate and appropriate target mask.	●	●
	Install the gloss calibration plate and appropriate target mask, and then perform calibration.	Gloss calibration was not performed using the correct procedure.	Perform gloss calibration using the provided gloss calibration plate and appropriate target mask.	●	
	Light shielding during 0% calibration was insufficient.	0% calibration was not performed using the correct procedure.	Install the white calibration plate correctly and perform correct 0% calibration with light completely blocked between the illumination window and receptor window.	●	●
	Light intensity at 100% calibration was insufficient.	100% calibration was not performed using the correct procedure.	Install the white calibration plate correctly and perform correct 100% calibration for the specimen that will be measured.	●	●
	A target mask is not installed. Install the target mask.	A target mask is not installed.	Install the appropriate target mask before performing measurement.	●	●
	The UV control coefficient does not exist. Perform UV control using the UV Control Software.	Measurement is not possible because UV control has not been performed for the set conditions.	Perform UV control for the set UV conditions from the UV Control Software that is provided with SpectraMagic NX before performing measurement.	●	
	Calibration data has not been set.	The calibration data for white calibration has not been written.	Write the calibration data to the instrument.	●	●
	Value exceeds the range that can be measured by the instrument.	Color measurement of that specimen is not possible.	To perform color measurement, measure using a different specimen.	●	●
	The specified operation cannot be executed because measurement is in progress.	The operation cannot be executed because measurement is in progress.	Wait for measurement to end before executing the operation.	●	●

Symptom	Displayed message	Possible cause	Correction	CM-36dG	CM-36d
	The specified operation cannot be executed because motor drive is in progress.	The operation cannot be executed because the motor that performs switching of the measurement area and SCI/SCE is currently operating.	Wait for motor operation to end before executing the operation.	●	●
	There was an operating failure of the A/D conversion device inside the instrument.	The A/D conversion device installed in the instrument has failed.	Turn the power OFF and then turn it ON again. If the message is displayed again, contact a KONICA MINOLTA-authorized service facility.	●	●
	There was an operating failure of light output circuit charging inside the instrument.	Charging of the light output circuit is not completed. The light output circuit is not operating correctly.		●	●
	There was an operating failure of the light output circuit inside the instrument.	The light output circuit installed in the instrument is not operating correctly.		●	●
	There was an operating failure of a motor inside the instrument.	The motor that performs switching of the measurement area, SCI/SCE, and gloss measurement is not operating correctly.		●	●
	There was an operating failure of memory inside the instrument.	The memory installed in the instrument is not operating correctly.		●	●
	The camera used to capture viewfinder images is not operating.	The camera installed in the instrument is not operating correctly.		●	●

# Troubleshooting

If an abnormality has occurred with the instrument, take the necessary actions as given in the table below. If the instrument still does not work properly, turn the power OFF, and then turn it ON again. If the conditions still do not return to normal, contact a KONICA MINOLTA-authorized service facility.

Symptom	Check Point	Action	Reference Page
The instrument does not start up even though the power is ON.	Is the AC adapter connected correctly to the instrument?	Correctly connect the AC adapter.	20
	Is the AC adapter that is supplied as a standard accessory (AC-A312F) connected?	Connect the AC adapter supplied as a standard accessory (AC-A312F).	9
Measurement results are abnormal. (Reflection (color), gloss <sup>◇</sup> )	Is the specimen placed properly?	Set the instrument so that the sample is in closest possible contact with the target mask surface.	28
	Is the target mask installed correctly?	Read "Installing the Target Mask," and install the target mask correctly.	21
	Is there foreign matter or other dirt on the inside of the integrating sphere?	Foreign matter or dirt larger than several mm may affect the measurement results. Foreign matter and dust inside the integrating sphere can easily scratch the barium sulfate paint on the inside of the sphere. Use a blower from the specimen measuring port to blow these substances off. If such substances cannot be removed with the blower, performing zero calibration and white calibration may improve performance.	17
	Has correct calibration data been written?	Set the data for the white calibration plate and gloss calibration plate <sup>◇</sup> that you are using.	For details, refer to the SpectraMagic NX (CM-S100w) instruction manual.
	Has zero calibration been performed correctly? (Reflection (color), gloss <sup>◇</sup> )	Read "Installing the Zero Calibration Box," install the zero calibration box correctly, and perform zero calibration.	23
	Has white calibration been performed correctly? (Reflection (color))	Read "Installing the White Calibration Plate," install the white calibration plate correctly, and perform white calibration.	24
	<sup>◇</sup> Has gloss calibration been performed correctly? (Gloss)	<sup>◇</sup> Read "Installing the Gloss Calibration Plate," install the gloss calibration plate correctly, and perform gloss calibration.	25

Symptom	Check Point	Action	Reference Page
Measurement results are abnormal. (Reflection (color), gloss <sup>Ⓢ</sup> )	Ⓢ Is there a foreign substance in the transmittance specimen chamber?	Ⓢ Remove the specimen or other substance from the transmittance specimen chamber.	30
	Is transmittance measurement selected as the measurement mode?	Refer to the software instruction manual and perform the operation correctly.	For details, refer to the SpectraMagic NX (CM-S100w) instruction manual.
Measurement results are abnormal. (Transmittance <sup>Ⓢ</sup> (color))	Is the specimen placed properly?	Set the instrument so that the sample is in closest possible contact with the target mask surface.	30
	Is the target mask installed correctly?	Read “Installing the Target Mask,” and install the target mask correctly.	21
	Is there foreign matter or other dirt on the inside of the integrating sphere?	Foreign matter or dirt larger than several mm may affect the measurement results. Foreign matter and dust inside the integrating sphere can easily scratch the barium sulfate paint on the inside of the sphere. Use a blower from the specimen measuring port to blow these substances off. If such substances cannot be removed with the blower, performing zero calibration and white calibration may improve performance.	17
	Has correct calibration data been written?	Set the data for the white calibration plate and gloss calibration plate <sup>Ⓢ</sup> that you are using.	For details, refer to the SpectraMagic NX (CM-S100w) instruction manual.
	Has 0% calibration been performed correctly?	Install the white calibration plate correctly and perform correct 0% calibration with light completely blocked between the illumination window and receptor window.	24
	Has 100% calibration been performed correctly?	Install the white calibration plate correctly and perform correct 100% calibration for the specimen that will be measured.	24
	Is reflectance measurement selected as the measurement mode?	Refer to the software instruction manual and perform the operation correctly.	—
Data input/output from the instrument to the computer is not possible. No commands from the computer are being accepted.	Is the USB cable connected correctly?	Connect the instrument and computer correctly to the USB cable.	19
	Is the software operating correctly?	Refer to the software instruction manual and perform the operation correctly.	For details, refer to the SpectraMagic NX (CM-S100w) instruction manual.

# Fluorescence Measurement

This instrument features both a UV full xenon lamp and a UV cut xenon lamp. Fluorescence reflectance is calculated through numerical processing of the reflectance from these two light sources.

## With fluorescence calibration

To ensure accurate fluorescence reflectance measurement, fluorescence calibration can be performed using the UV Control Software that is provided with SpectraMagic NX (Ver. 3.2 and later).

## Finding the fluorescence reflectance

The fluorescence amount is determined for each reflectance wavelength under both the UV full light source and the UV cut light source by measuring a fluorescence standard plate. The fluorescence correction coefficient is determined to ensure the measured values are matched to the given target values.

(Calibration example: Profile mode)

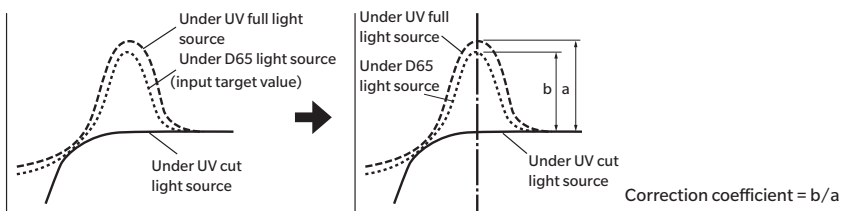

The fluorescence correction coefficient is used to determine the fluorescence reflectance through numerical processing of a measurement object's reflectance under the UV full light source and under the UV cut light source. (The reflectance of the cut wavelength region for UV cut lighting is uniform at 0%.)

This allows the instrument to approximate the output fluorescence amount under any reference light source, such as a D65 light source, without increasing or decreasing the amount of UV light as with conventional models.

## Without fluorescence calibration

The spectral distribution characteristics of the instrument's UV full xenon lamp are close to that of a D65 light source, making it possible to measure fluorescence reflectance with ordinary reflectance measurement if strict accuracy is not required for the fluorescence measurement.

## UV cut light source

This instrument can be equipped with a UV400 or UV420 option as a UV cut light source.



# Specifications

		CM-36dG					CM-36d		
Color	Illumination/ viewing system	Reflectance	di: 8°, de: 8° (diffused illumination, 8° viewing angle) SCI (specular component included) / SCE (specular component excluded) switchable Conforms to CIE No. 15 (2004), ISO7724/1, ASTM E1164, DIN 5033 Teil7, JIS Z 8722 Condition c standard						
		Transmittance	di: 0°, de: 0° (diffused illumination, 0° viewing) Conforms to CIE No. 15 (2004), ASTM E1164, DIN 5033 Teil7, JIS Z 8722 Condition g standard					-	
	Size of integrating sphere	ø152 mm (6 inches)							
	Detector	Dual 40-element silicon photodiode arrays							
	Spectral separation device	Diffraction grating							
	Wavelength range	360 to 740 nm							
	Wavelength pitch	10 nm							
	Half bandwidth	Approx. 10 nm							
	Reflectance range	0 to 200%; Resolution: 0.01%							
	Light source	Pulsed xenon lamps × 3 (2 with UV cut filters)					Pulsed xenon lamp × 1		
		LAV	LMAV	MAV	SAV	Transmittance	LAV	MAV	SAV
	Illumination area (mm)	ø30	ø20	ø11	ø7	ø24	ø30	ø11	ø7
	Measurement area (mm)	ø25.4	ø16	ø8	ø4	ø17	ø25.4	ø8	ø4
	Repeatability	Colorimetric values: Standard deviation within $\Delta E^*ab$ 0.02 Spectral reflectance: Standard deviation within 0.1% (When a white calibration plate is measured 30 times at 10-second intervals after white calibration)					Colorimetric values: Standard deviation within $\Delta E^*ab$ 0.03 Spectral reflectance: Standard deviation within 0.1% (When a white calibration plate is measured 30 times at 10-second intervals after white calibration)		
	Inter-instrument agreement	Within $\Delta E^*ab$ 0.12 (Based on average for 12 BCRA Series II color tiles; LAV/SCI. Compared to values measured with a master body under Konica Minolta standard measurement conditions)					Within $\Delta E^*ab$ 0.15 (Based on average for 12 BCRA Series II color tiles; LAV/SCI. Compared to values measured with a master body under Konica Minolta standard measurement conditions)		
	UV setting	100% / 0% / Adjusted (Instantaneous numerical adjustment of UV with no mechanical filter movement required)*1; 400 nm and 420 nm UV cutoff filters					No adjustment function (UV100%)		

\*1 Numerical adjustment of UV requires UV Adjustment Software (included with optional SpectraMagic NX Pro Ver. 3.2 or later).

		CM-36dG	CM-36d
Gloss	Measurement angle	60°	-
	Light source	White LED	-
	Detector	Silicon photodiode	-
	Measurement range	0-200 GU; Resolution: 0.01 GU	-
	Measurement area	MAV (LAV/LMAV/MAV color measurement area): 10 × 8 mm ellipse SAV (SAV color measurement area): Ø3 mm	-
	Repeatability	Standard deviation within 0 to 10 GU: 0.1 GU 10 to 100 GU: 0.2 GU 100 to 200 GU: 0.2% (When measured 30 times at 10-second intervals)	-
	Inter-instrument agreement	0 to 10 GU: ±0.2 GU 10 to 100 GU: ±0.5 GU (MAV. Compared to values measured with a master body under Konica Minolta standard conditions)	-
Geometry	JIS-Z8741 (MAV), JIS-K5600, ISO2813, ISO7668 (MAV), ASTM D523-08, ASTM D2457-13, DIN 67530	-	
Measurement time	Approx. 3.5 seconds (SCI+SCE measurement) Approx. 4 seconds (SCI+SCE+GLOSS measurement)	Approx. 3.5 seconds (SCI+SCE measurement)	
Minimum interval between measurements	Approx. 4 seconds (SCI+SCE measurement) Approx. 4.5 seconds (SCI+SCE+GLOSS measurement)	Approx. 4 seconds (SCI+SCE measurement)	
Sample viewer function	Using internal camera. Image viewable/copiable using optional software such as SpectraMagic NX Ver. 3.2 or later		
Internal Performance Check <sup>*2</sup>	WAA (Wavelength Analysis & Adjustment) Technology		
Interface	USB 2.0		
Target mask auto detection	Yes		
Power	Dedicated AC adapter		
Operating temperature/humidity range	Temperature: 13 to 33°C, Relative humidity: 80% or less (at 33°C) with no condensation		
Storage temperature/humidity range	Temperature: 0 to 40°C, Relative humidity: 80% or less (at 35°C) with no condensation		
Size (W×H×D)	Approx. 248×250×498 mm		
Weight	Approx. 8.4 kg	Approx. 8.3 kg	

For details of the measurement items (various color spaces, indexes, color difference equations), refer to the special catalog for the optional SpectraMagic NX color data software.

\*2 WAA license purchase required.

# Dimensions

CM-36dG

(Unit: mm)

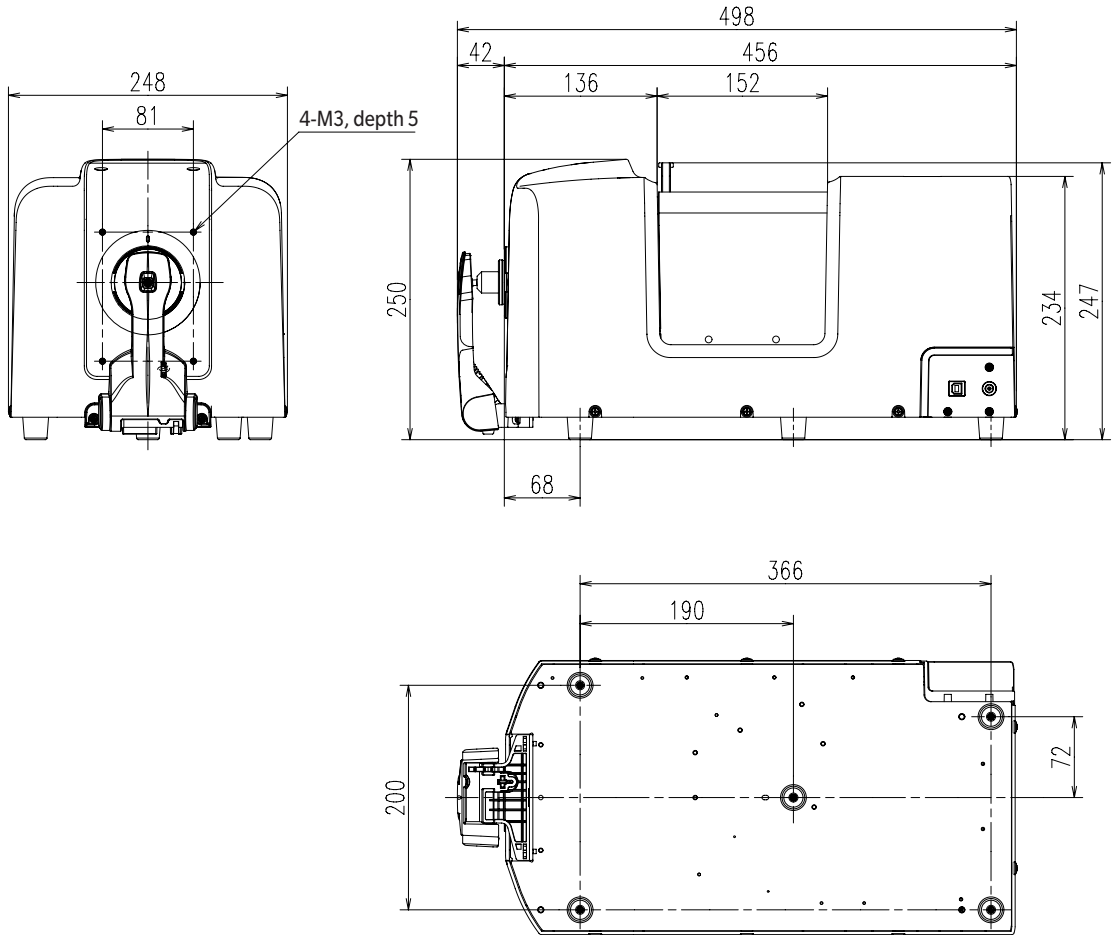

CM-36d

(Unit: mm)

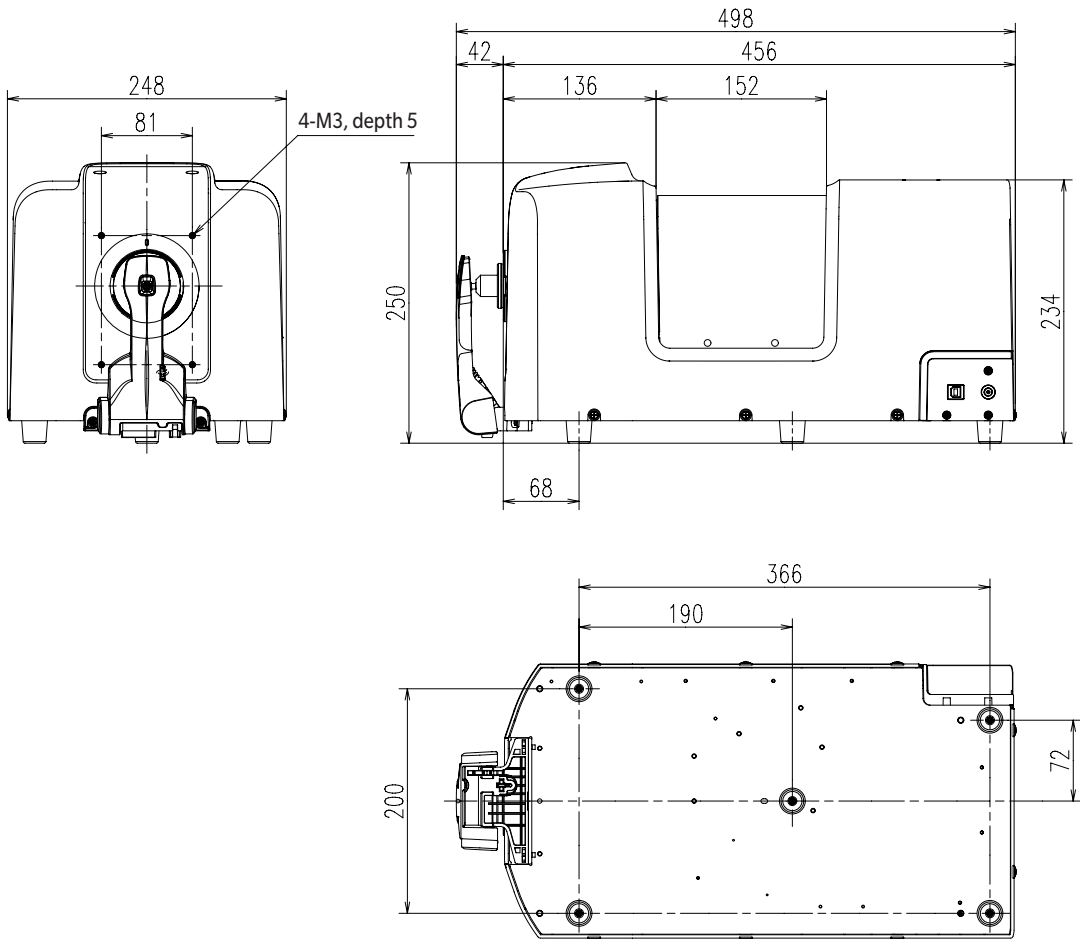

**<CAUTION>**

- **KONICA MINOLTA WILL NOT BE LIABLE FOR ANY DAMAGES RESULTING FROM THE MISUSE, MISHANDLING, UNAUTHORIZED MODIFICATION, ETC. OF THIS PRODUCT, OR FOR ANY INDIRECT OR INCIDENTAL DAMAGES (INCLUDING BUT NOT LIMITED TO LOSS OF BUSINESS PROFITS, INTERRUPTION OF BUSINESS, ETC.) DUE TO THE USE OF OR INABILITY TO USE THIS PRODUCT.**



KONICA MINOLTA